

1 2 3 4 5 6

A

A

B

B

C

C

D

D

MARK	DATE	REVISION	REVISER	APP .BY
①				
②				
③				

MODEL NO		SEWN30E		
MATERIAL		HOUSING-AL HORN HOUSING-PC/ SUS316L		
USE VOLT.	CURRENT	DC12V	2.211A	
		DC24V	1.022A	
		AC110V	0.226A	
		AC220V	0.113A	
KIND OF SOUND		WS	5 Warning Sounds	
		WP	5 Special Warning Sounds	
		WM	5 Melodies	
		WA	5 Alarms	
		WV	5 Customizable sounds	
VOLUME		MAX. 118dB		
PROTECTION GRADE		WATER & DUST PROOF IP56		
CABLE ENTRY		PF1/2"		
COLOR OF HOUSING		MUNSELL NO. 7.5BG 7/2		

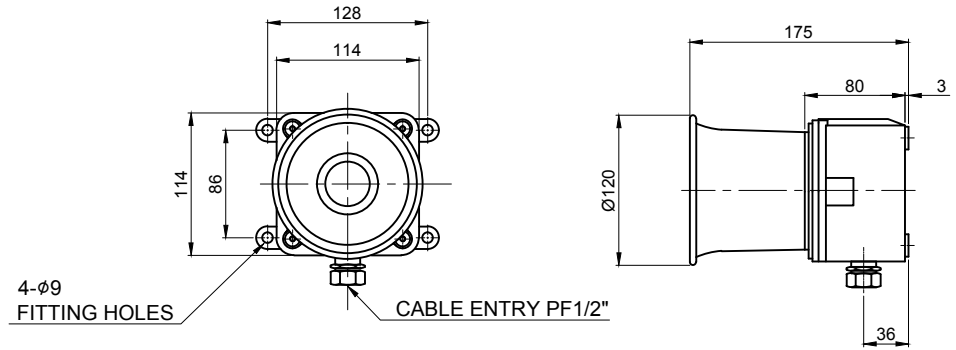

	ISO2768-1 : CLASS OF TOLERANCE					SURFACE FINISH
	f	m	Ⓢ	v		
FOR LINEAR DIMENSIONS	0.5~3	±0.05	±0.1	±0.2	-	
	3~6			±0.3	±0.5	
	6~30	±0.1	±0.2	±0.5	±1	
	30~120	±0.15	±0.3	±0.8	±1.5	
	120~400	±0.2	±0.5	±1.2	±2.5	
400~1000	±0.3	±0.8	±2	±4		
FOR ANGULAR DIMENSIONS	0~10	±1°		±1°30'	±3°	
	10~50	±0°30'		±1°	±2°	
	50~120	±0°20'		±0°30'	±1°	
	120~400	±0°10'		±0°13'	±0°30'	

Nr.	DWG. NO.	TITLE/ NAME		MAT'L	QTY	REFERENCE
DSND BY	CHKD BY	CHKD BY	APRV BY	VIEW	DATE	
S.H.KIM	J.H.PARK		J.K.HAN	3	2019.03.20	
TITLE			MODEL			
SEWN30E OUTLINE DRAWING			SEWN30E			
			DWG. NO.			
			SEWN30E_OUT			
SCALE	SIZE	REV	SHEET			
N/S	A4	00	1/1			

1 2 3 4 5 6

A4(297X210)