

Electric Horns for Vessels and Heavy Industrial Applications

SN/ SEHN25/ SEHN50

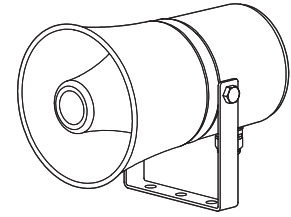

Thank you for purchasing Qlight's products. Please read this user manual carefully prior to installation and operation to ensure safe and correct use.

⚠️ Precautions for Safety

Failure to follow the instructions below may cause a loss of life or serious physical injury.

1. During wiring or maintenance, please completely turn off the power of the product. (Failure to follow this may lead to an electric shock.)
2. Do not install the product in locations that subjects it to excessive dust or water other than the conditions designated by the IP protection ratings indicated for each product. (Failure to follow these instructions may cause a fire to the product, electric shock, physical injury, malfunction or damage to the product.)
3. Do not alter or repair this product. If maintenance or repair service is required, please contact your local Qlight contact point. (Failure to follow these instructions may lead to fire, electric shock, or product damage.)
4. Please apply the correct voltage to the product. (Failure to follow these instructions may lead to fire, electric shock, or product damage.)
5. When the product is applied to a condition that may impact lives or property, please make sure to have a double safety device. (Failure to follow this may cause damage to property, fire, electric shock and loss of life.)

⚠️ Precautions for Correct Use

Failure to follow the proper instructions may cause damage to property, the product, or malfunction of the product that would void the warranty.

1. Please remove any objects that can interrupt ventilation around the product.
2. Please turn off the power of the product immediately if it fails to operate properly.
3. Carefully wire the product according to each product's specification.
4. Please be careful in preventing chemicals such as thinner, benzene, etc. in contact with the surface of the product.
5. Do not apply excessive force/impact to the product.
6. Failure to follow any of the instructions above may cause malfunction or damage to the product, fire, and electric shock.

Ordering Specifications

SEHN25 [Model number]	WA [Sound]	24 [Voltage]	LC [Sound selection]
• SN	<ul style="list-style-type: none"> • WS -Warning sounds • WP-Special warning sounds • WM-Melodies • WA-Alarms • WV-Customizable sounds 	<ul style="list-style-type: none"> • 12/24 - DC12V-24V • 110 - AC110V • 220 - AC220V 	<ul style="list-style-type: none"> • (Blank) - Standard type • LC Type -Uses external contact
• SEHN25 • SEHN50	<ul style="list-style-type: none"> • WS -Warning sounds • WP-Special warning sounds • WM-Melodies • WA-Alarms • WV-Customizable sounds 	<ul style="list-style-type: none"> • 12 - DC12V • 24 - DC24V • 110 - AC110V • 220 - AC220V 	<ul style="list-style-type: none"> • (Blank) - Standard type • LC Type -Uses external contact

Product Specifications

Model number	Voltage	Current	Sound pattern and volume	Certificate	Weight
SN	DC12V-DC24V	Max. 0.265A	<ul style="list-style-type: none"> • WS - 5 Warning Sounds • WP - Special warning sounds • WM - 5 Melodies • WA - 5 Alarms • WV - 5 Customizable sounds 	CE	0.91kg
	AC110V	0.065A			1.06kg
	AC220V	0.030A			
SEHN25	DC12V	2.211A	<ul style="list-style-type: none"> • WS - 5 Warning Sounds • WP - Special warning sounds • WM - 5 Melodies • WA - 5 Alarms • WV - 5 Customizable sounds 	KIMM	2.26kg
	DC24V	1.022A			2.48kg
	AC110V	0.226A			
SEHN50	AC220V	0.113A	<ul style="list-style-type: none"> • WS - 5 Warning Sounds • WP - Special warning sounds • WM - 5 Melodies • WA - 5 Alarms • WV - 5 Customizable sounds 	KIMM	2.67kg
	DC12V	2.440A			
	DC24V	1.186A			
	AC110V	0.244A			
	AC220V	0.122A			3.30kg

※ CE compliant : AC220V(SN only)

- Protection rating : IP55
- Ambient operating temperature : -25°C to +50°C



Please scan the QR code for more detailed product information.

www.qlight.com

SN

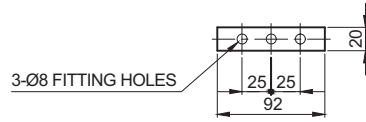
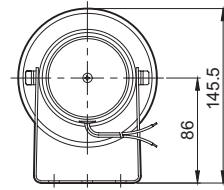
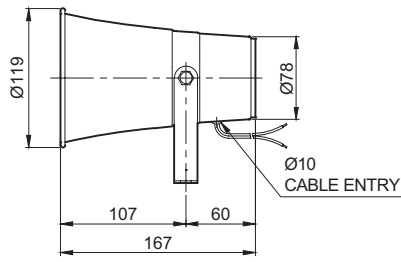

SEHN25

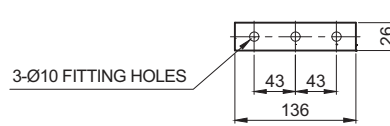
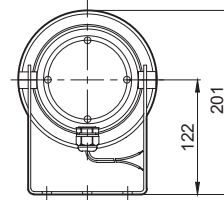
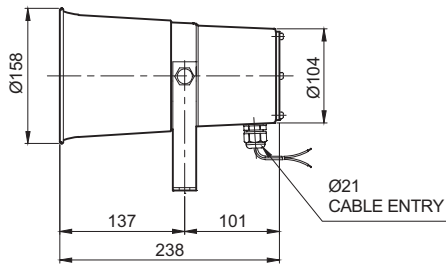

SEHN50

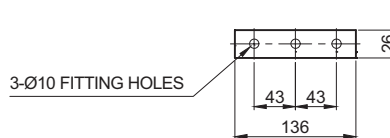
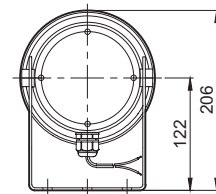
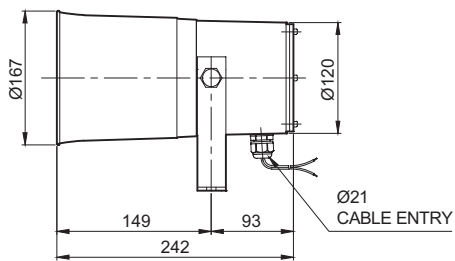

Sound Selection - Using Internal Switch (Built-in Sound Type)

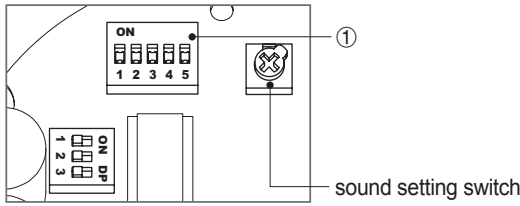

- Standard unit has 5 built-in sound tones. select different built-in sounds using the sound setting switch.

■ Sound Type by Group

Category	Sound pattern	Channel	Sound tone	Volume (Max.)		
				SN	SEHN25	SEHN50
WS	5 Warning sounds	Ch1	Fire.A-ANG	105dB	115dB	120dB
		Ch2	Emergency WA-U			
		Ch3	Ambulance PI-PO			
		Ch4	Machinery Fault			
		Ch5	High Expansion			
WM	5 Melodies	Ch1	Sweet Home	105dB	115dB	120dB
		Ch2	For Elise			
		Ch3	Cuckoo's Waltz			
		Ch4	Piano Sonata			
		Ch5	Turkish March			
WA	5 Alarms	Ch1	Beep Intermittent	103dB	113dB	118dB
		Ch2	Door Chime			
		Ch3	Phone Ring			
		Ch4	PI.PI.PI Short			
		Ch5	Tripping Beat			
WV	5 Customizable sounds	Ch1	Available upon request (customized voice type)	95dB	108dB	115dB
		Ch2				
		Ch3				
		Ch4				
		Ch5				

Wiring Instructions for LC Type

- LC type product with exposed sound selection signal line is available upon request. Please refer to the diagram below for wiring.

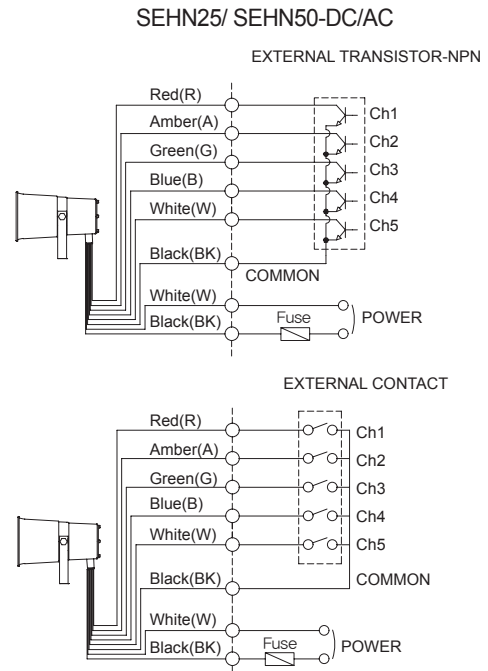

- External power line - UL1015 AWG18(0.75sq) x 2C 400mm
- LC type external signal line - UL1007 AWG22(0.3sq) 400mm
- This product can be wired regardless of polarity.

Volume Adjustment

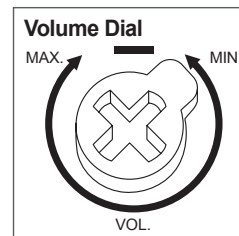

- The volume output of this product is adjustable.
- Turn the volume dial clockwise to increase the volume, and turn counter clockwise to decrease the volume.
- There will be no sound when the dial is put at MIN.

Parts Definition/ Installation/ Adjusting the Angle of the Horn housing

■ Parts Definition

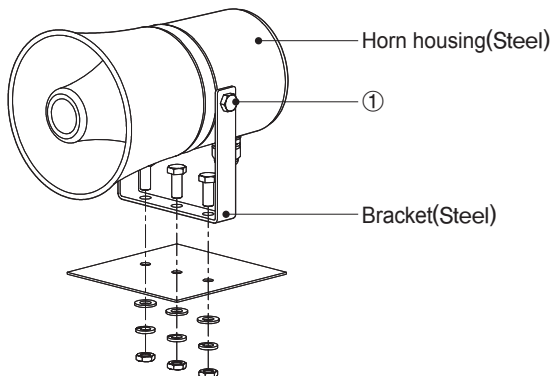

■ Parts Installation

- First, machine taps or holes on the mounting surface .
- The mounting hole of this product is 8mm(SN only), 10mm in diameter.
- When machining taps, fasten the bolt through the mounting hole of the product.
- When machining holes, insert the bolt through the hole of the product, and tighten the nut from the opposite side of the mounting surface
- When assembling using bolt and nut, please make sure to use flat washer and spring washer.

■ Adjusting the Angle of the Horn housing

- When adjusting the phase and lower angle of the mixed housing (signalling angle) after product cancellation Loosen the bracket fixing bolts(①) on the side of the product slightly to adjust the desired angle.

Mounting Hole Specifications

- Machine holes on the mounting surface referring to the diagram below.

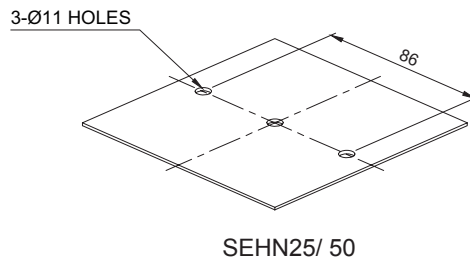
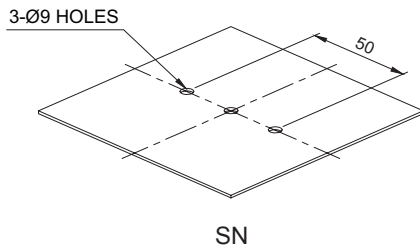

Installation Environment and Protection Rating

- This product is designed for use with protection rating of IP55.
- If the product is installed in locations that subject it to excessive dust or water other than the designated IP protection rating indicated (IP55), it may cause malfunction or damage to the product.
- In case of outdoor applications, install the product in the upright position. Do not install the product horizontal or upside-down positions where water can potentially penetrate into the product and impact its operation.
- For further information, please visit our website (www.qlight.com).

Technical Certification

- Qlight products are designed to meet strict quality and technical standards. Thus, the Qlight brand is widely recognized for its high quality and technical innovations from leading institutions around the world.



ISO International Organization for Standardization

Qlight quality assurance systems have been certified by ISO by applying the ISO 9001:2008, KS Q ISO 9001:2009 regulation.



IECEX International Explosion Proof Certification (IECEX)

Certified that Qlight's products are being manufactured and manage according to international standards.



ATEX The European Regulatory Framework or Manufacture, Installation and Use of Equipment in Explosive Atmospheres

Qlight's explosion proof products comply with ATEX Directives 94/9/EC.



NEPSI National Supervision and Inspection Center for Explosion Protection and Safety of Instrumentation

Qlight's design and manufacturing system meets the People's Republic of China National explosion proof Standard. (Chinese Standard-GB3836/GB12476)



KCs Explosion Proof Device Safety Certification System

The safety performance of machines and equipment subject to safety certification and Technical capability and production system have been certified safety certification standards.



TIIS Japan Explosion-proof Certification

TIIS is a Japanes explosion proof test and certification system accordance with the Ministry of Health, Labour and Welfare Notice and the explosion proof guidelines for factory electrical equipment. Qlight's explosion proof products have been tested and certified by TIIS.



ABS American Bureau of Shipping

Qlight's design and quality assurance system has been certified by the American Bureau of Shipping.



RMRS Russian Maritime Register of Shipping

Qlight's design and quality assurance system has been certified from Russian Maritime Register of Shipping.



CCS China Classification Society

Qlight's design and quality assurance system has been certified by the China Classification Society.



KR Korean Register of Shipping

Qlight's design and quality assurance system has been certified by the Korean Register of Shipping.



LR Lloyd's Register

Qlight's design and quality assurance system has been certified from Lloyd's Register.



E-mark Commission Directive Regarding Vehicle Industry

Qlight has obtained EU mark for approved vehicles and vehicle components sold into the EU (EEA : European Economic Area)



KC Korea Safety Certification

Qlight's products are certified by KC for preventing accident caused by fire.



KCC Conformity Assessment of Broadcasting Communication Equipment

Qlight has been certified to protect the electromagnetic environment that causes unwanted electromagnetic waves from the device, communication failure due to other devices or external radio waves, and malfunction of the device.



CCC China Compulsory Certificate

Qlight's has obtained CCC which guarantees safety, protection against fraud, environment, etc.



CCCF China Certification Center for Security & Protection

Qlight has passed the rigorous examination process of "Passing Fire Protection Products Centering" In order to sell fire-fighting products such as fire alarm equipment to Chinese market.



UL Underwriters Laboratories

Qlight's design and quality assurance system has been certified from UL to ensure the stability of consumption goods and to protect consumers.



CE European Commission

Qlight has been certified by the European Commission.



ICAO International Civil Aviation Organization

Qlight guarantees our products satisfy the criteria regulated by the International Civil Aviation Organization (ICAO, FAA).



RoHS2 Restriction of Hazardous Substances Directive

Qlight c omplies with the Restriction of Hazardous Substances Directive by limiting its use of hazardous materials.

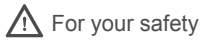

For your safety

Specification and dimensions listed in this catalogue subject to change without notice for product quality improvement.
The newest product information is available on our website.(www.qlight.com)
Please read the instruction manual attached to the product carefully before installation and use.

Qlight Co., Ltd. www.qlight.com | trade@qlight.com

Head Office | Suite #1510, STX-V Tower, 128 Gasan digital 1-ro, Geumcheon-gu, Seoul, Korea Tel. +82-80-328-2222 Fax : +82-2-2679-6154

Factory | 185-25, Mukbang-ro, Sangdong-myeon, Gimhae-si, Gyeongsangnamdo, Korea Tel. +82-80-328-1111

Qlight Overseas Sales Dept | 704 Nakdong-daero, Sasang-gu, Busan, Korea(Eomgung-Dong) Tel : +82-51-620-4100

Qlight Public Relations & Marketing Team Office | 704 Nakdong-daero, Sasang-gu, Busan, Korea(Eomgung-Dong) Tel : +82-51-245-0017

Qlight USA, Inc. www.qlight.com www.qlightusa.com | sales@qlightusa.com

3003 North First Street, Suite #341, San Jose, CA 95134 USA Tel. +1.408.519.5740 Fax. +1.408.519.5739

SHANGHAI Qlight Electronic Co., Ltd. www.qlight.com www.qlightcn.com | qlightcn@qlight.com

China Factory/ Shanghai Sales Office | #19, Nanda Road, Baoshan Area, Shanghai, China Tel. +86.21.6651.7100 Fax. +86.21.6315.3929

Qlight
Innovation in Alarm & Signal

Product Operation Inquiry / Customer Support +82-51-620-4100

You can expect prompt service if you have exact information such as model name, symptom, telephone number and address.

※ALL PRODUCT, PRODUCT SPECIFICATIONS AND DATA ARE SUBJECT TO CHANGE WITHOUT NOTICE TO IMPROVE RELIABILITY, FUNCTION OR DESIGN OR OTHERWISE.

Head office : Suite #1510, STX-V Tower, 128 Gasan digital 1-ro, Geumcheon-gu, Seoul, Korea (Postal Code : 08507)

Factory : 185-25, Mukbang-Ro, Sangdong-Myeon, Gimhae-Si, Gyeongsangnam-Do, Korea (Postal Code : 50805)

www.qlight.com

EN - SEHN25T -1911A